





Redesigning the hawker stall
An oscillating space in the city

Phase 1: observing

Instructed by Haotian Zhang

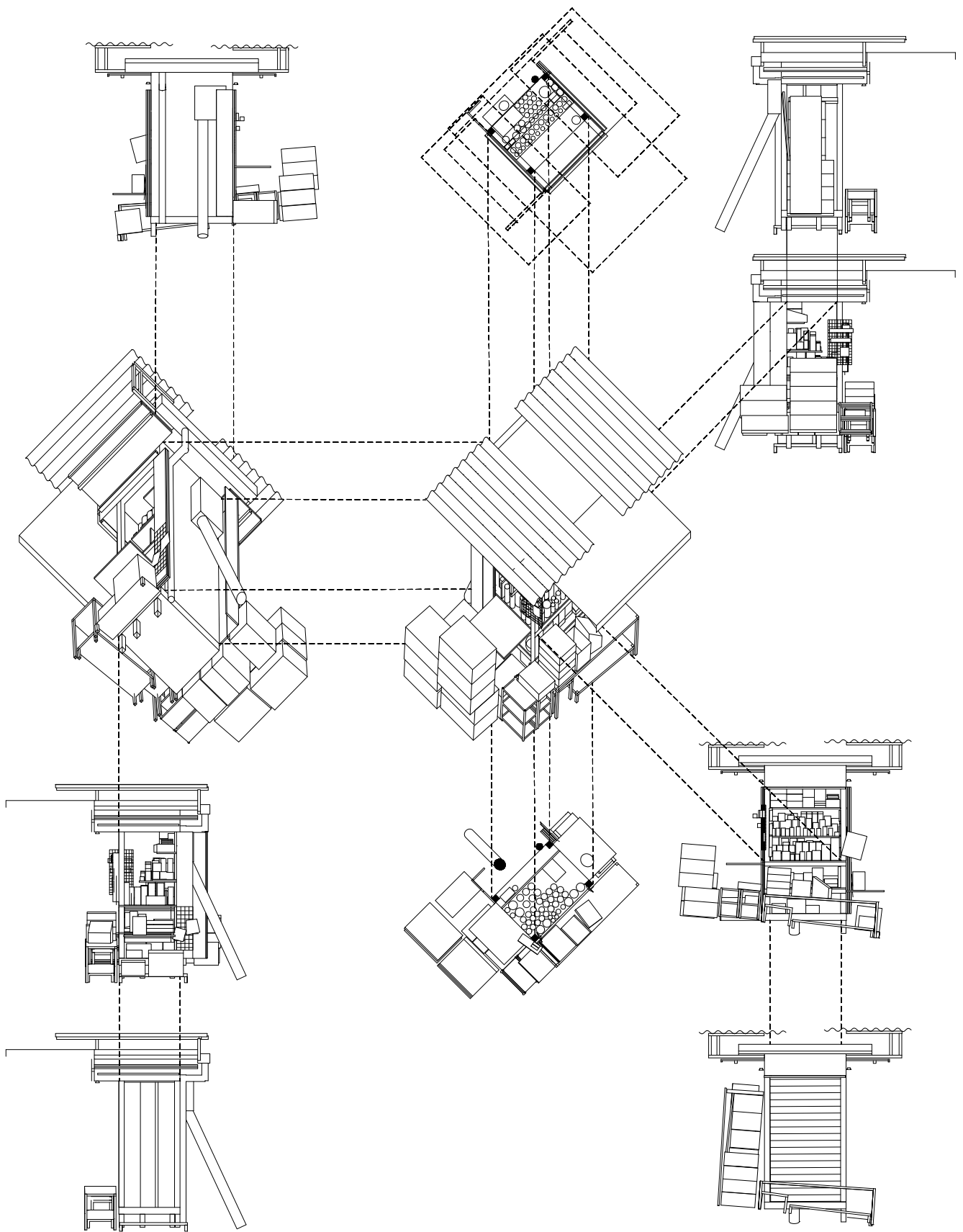

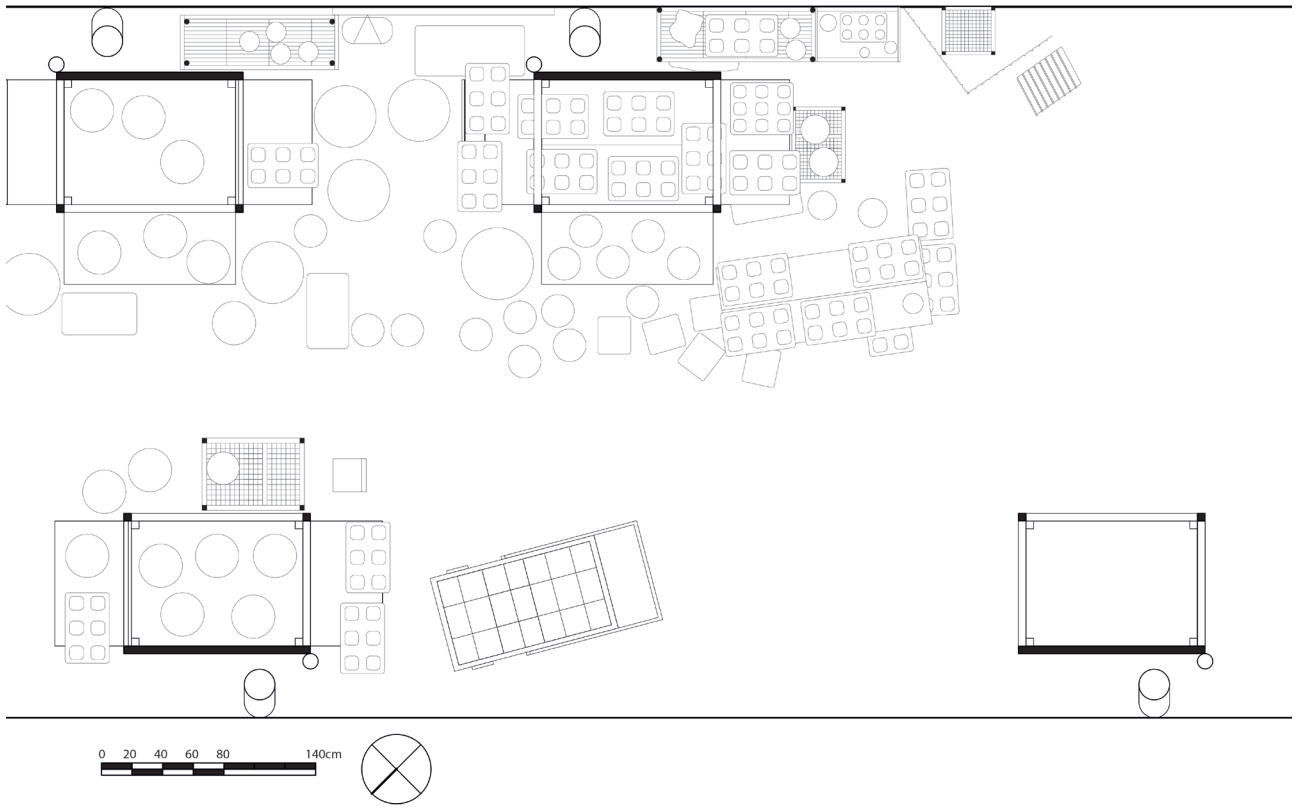

Ng Tin Lok Ryan

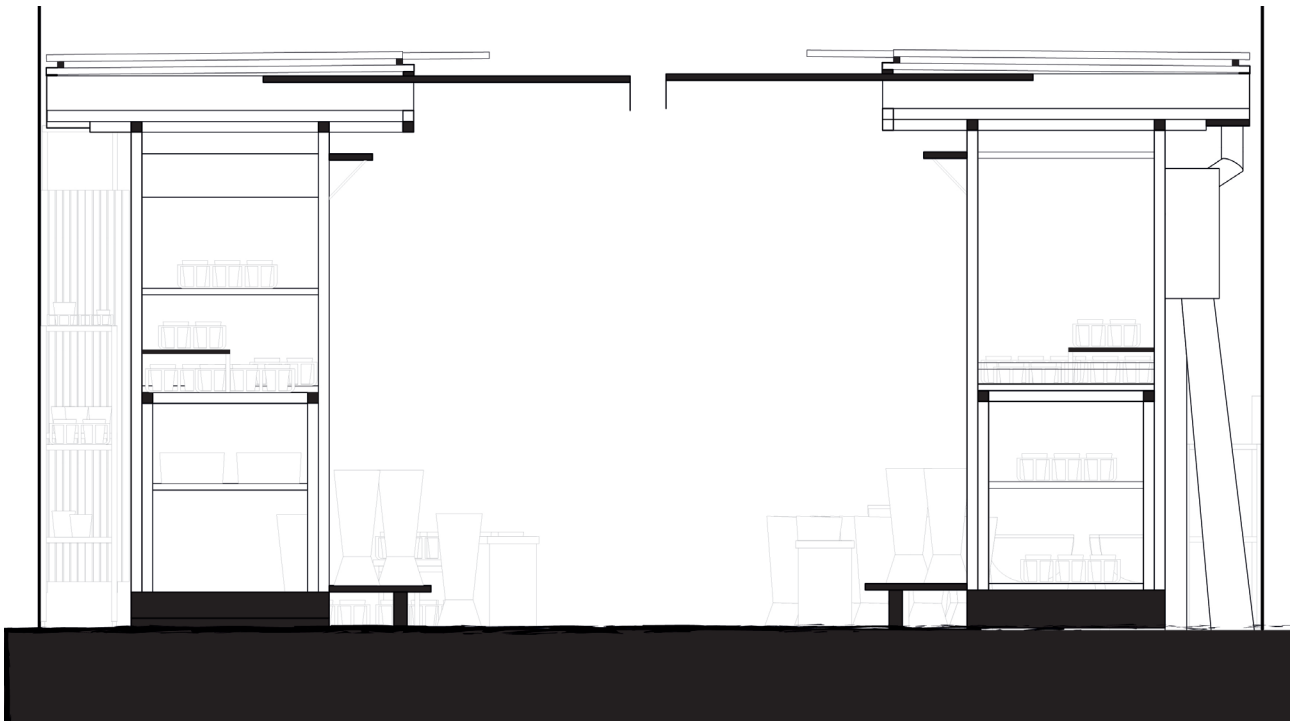





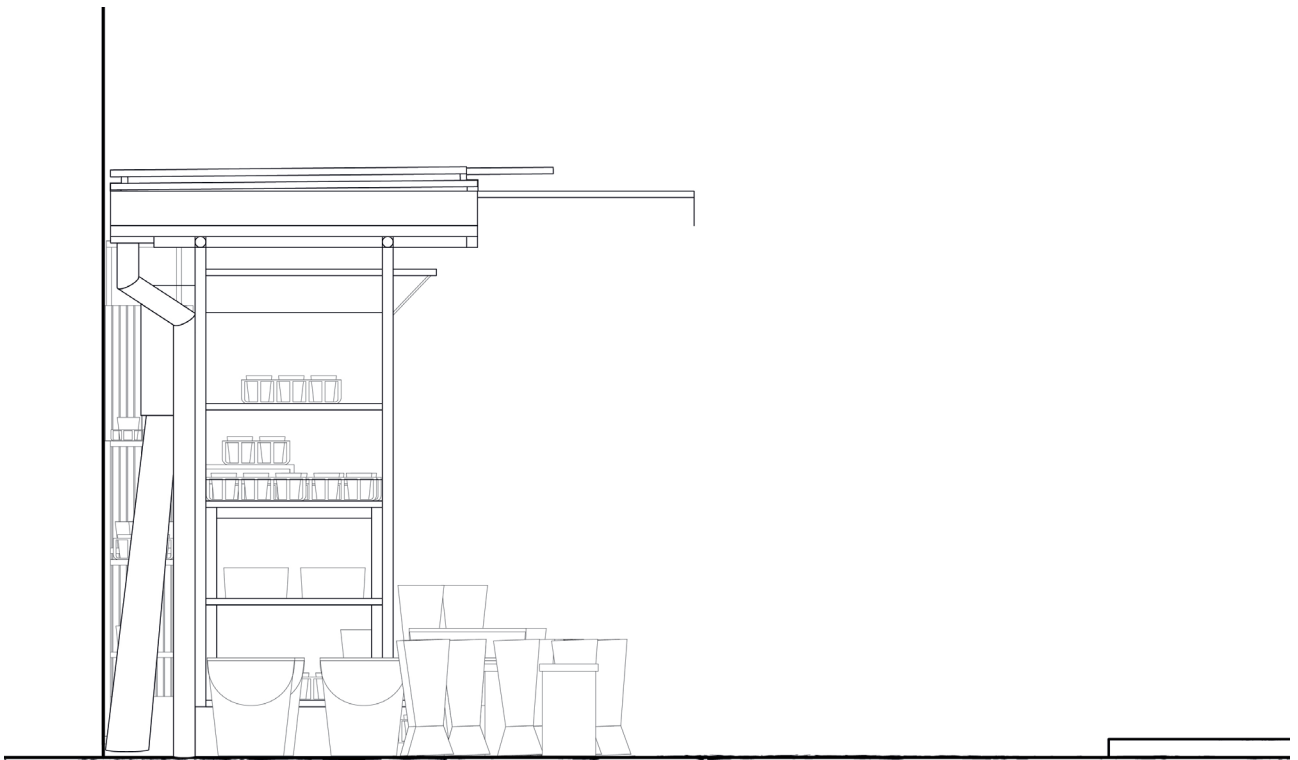

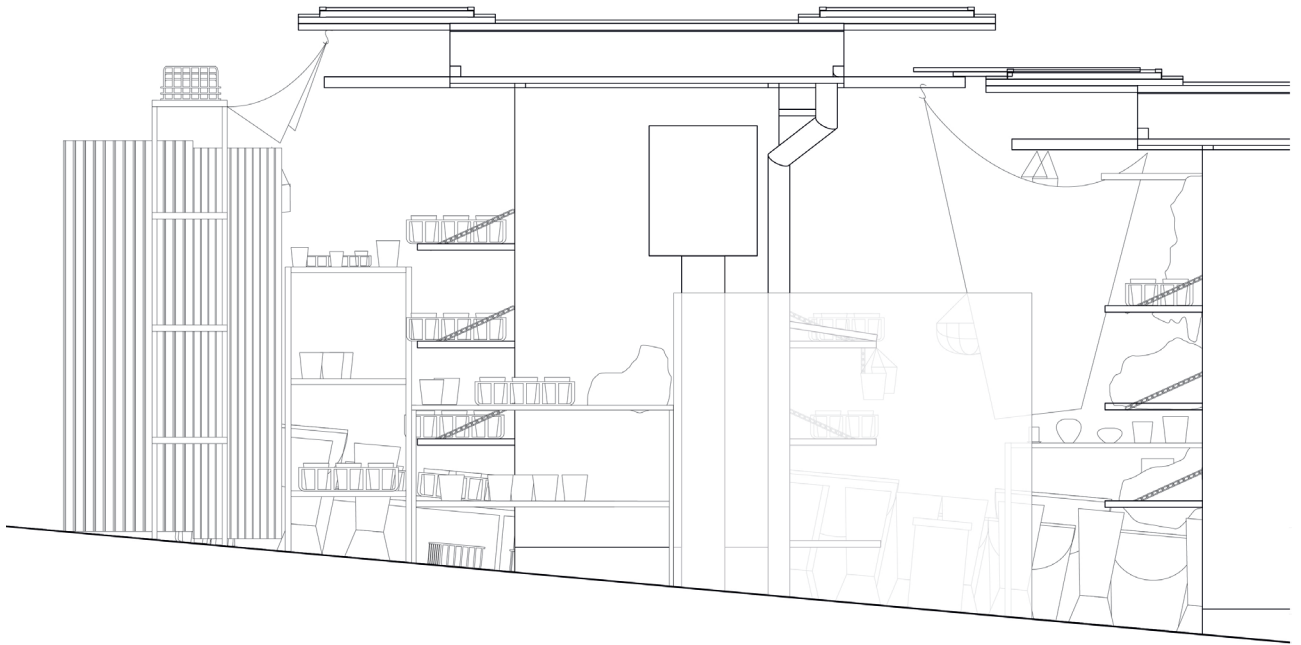

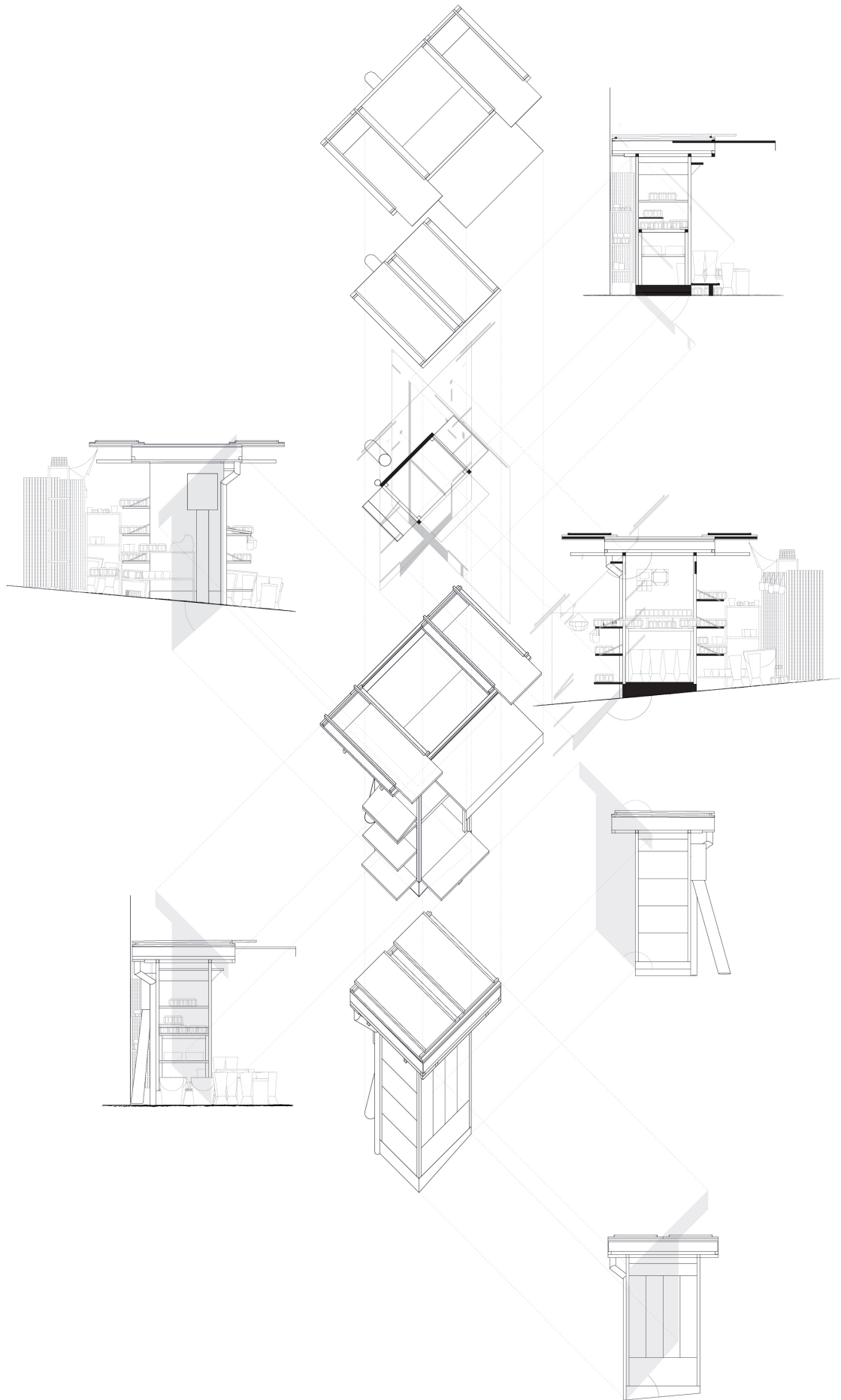

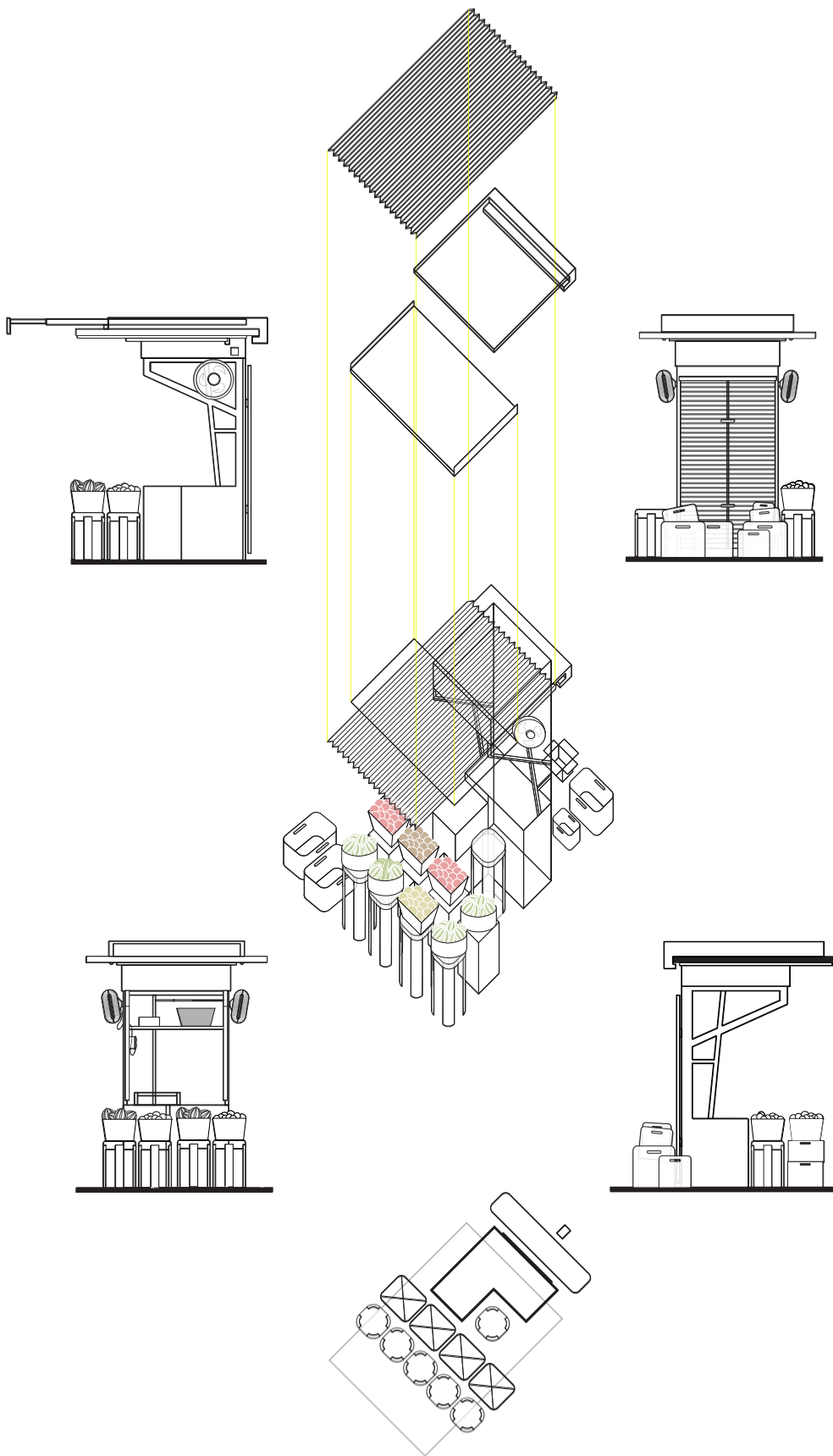

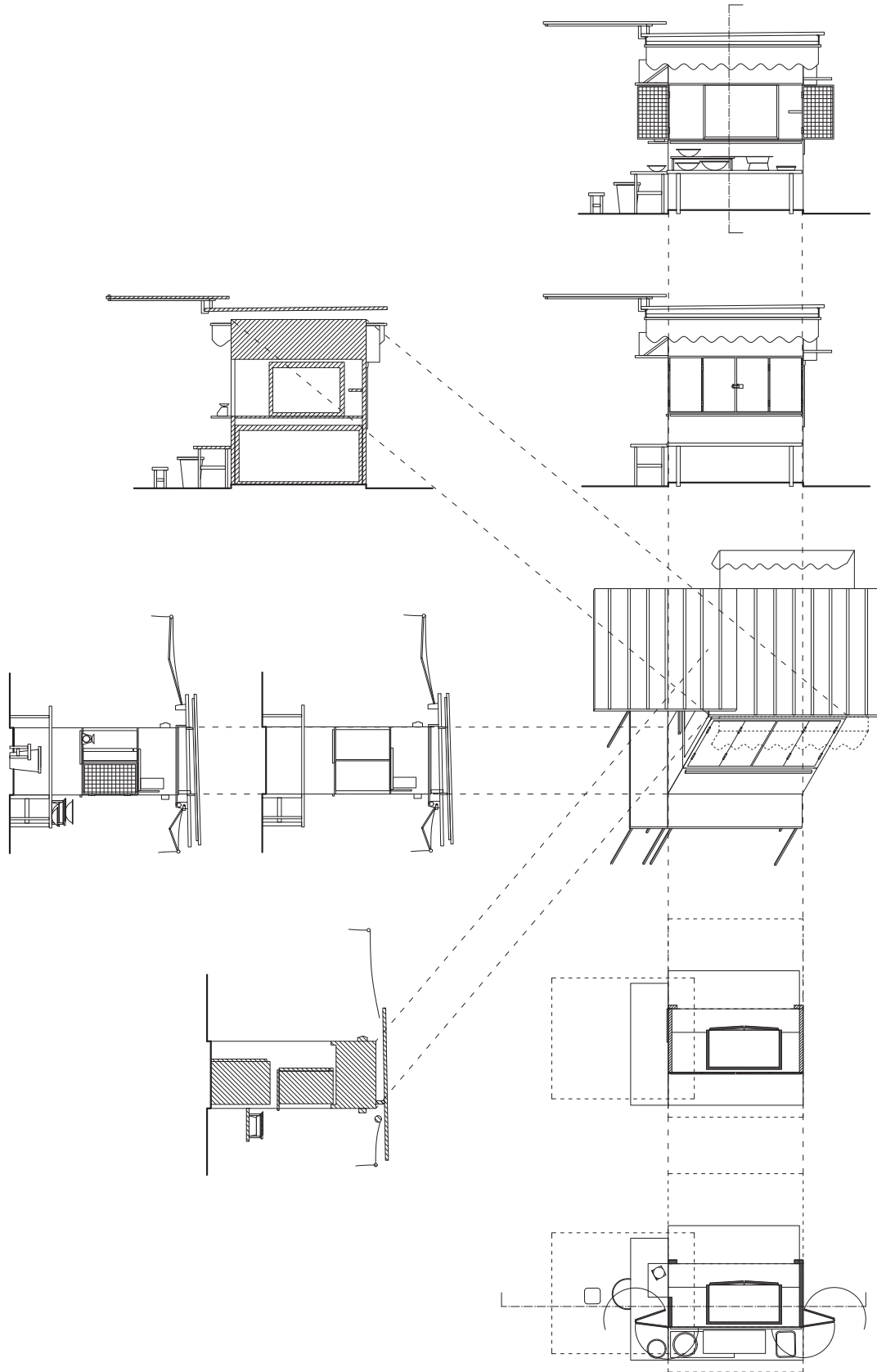

Tong Hui Yan Agnes



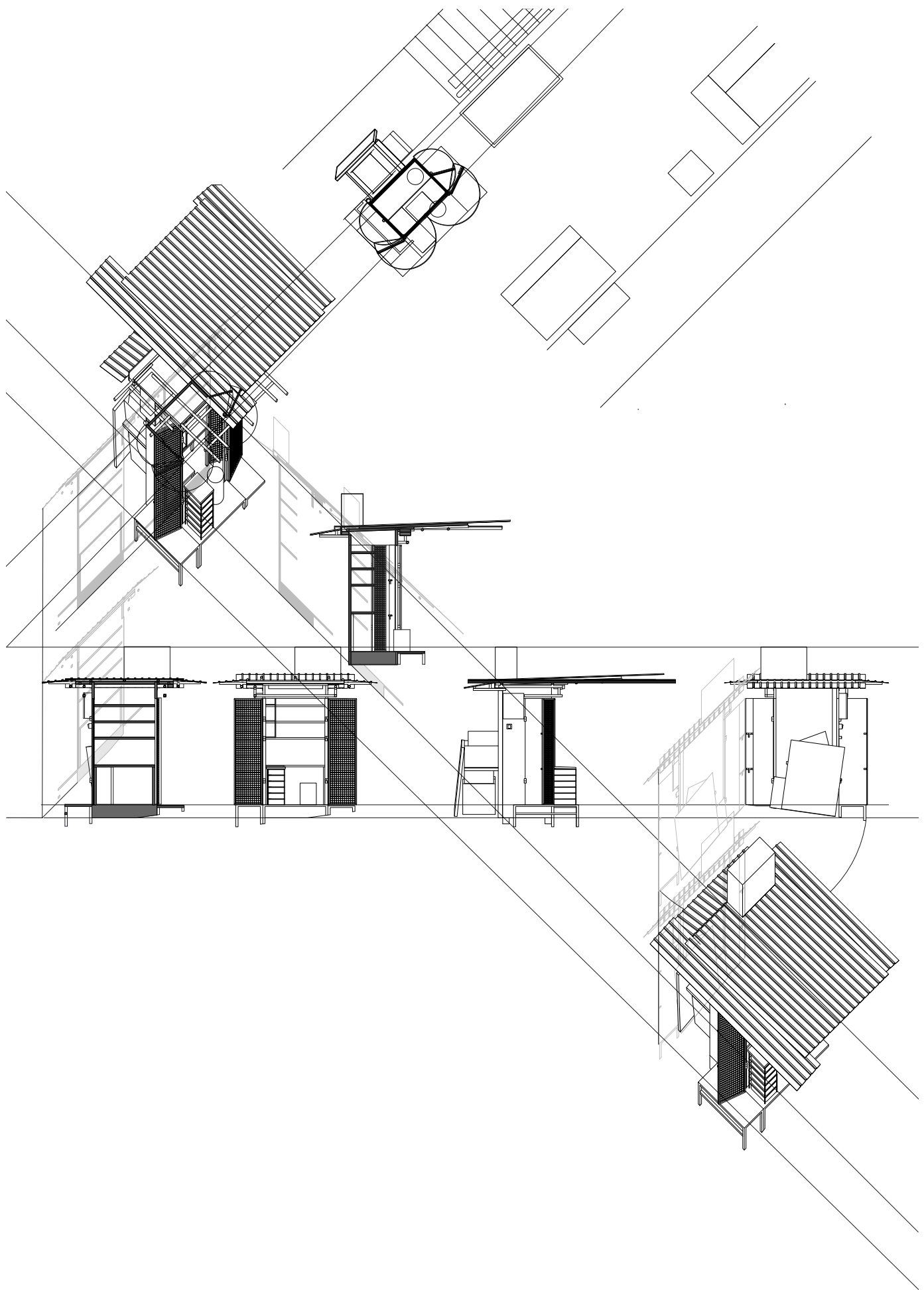

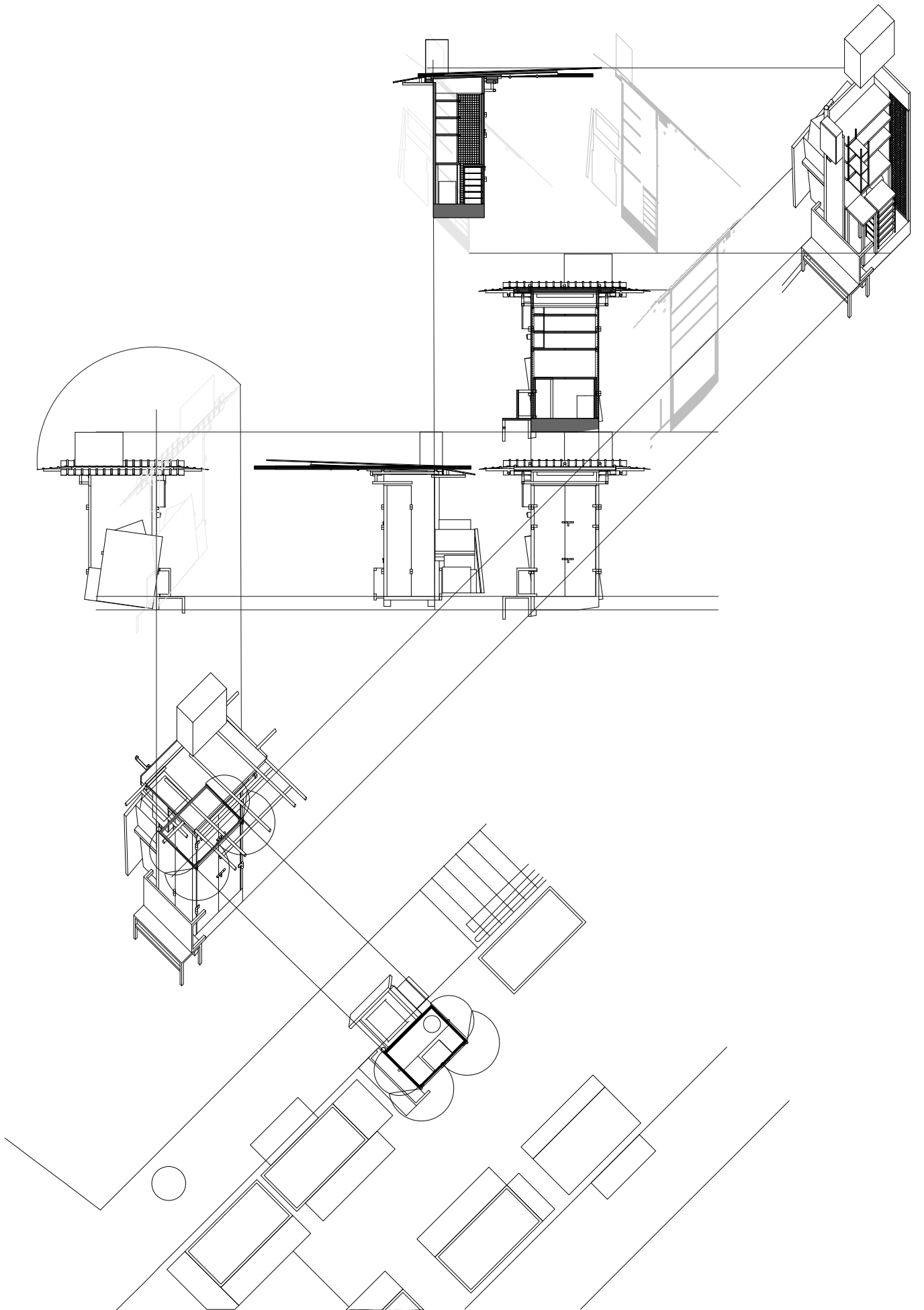





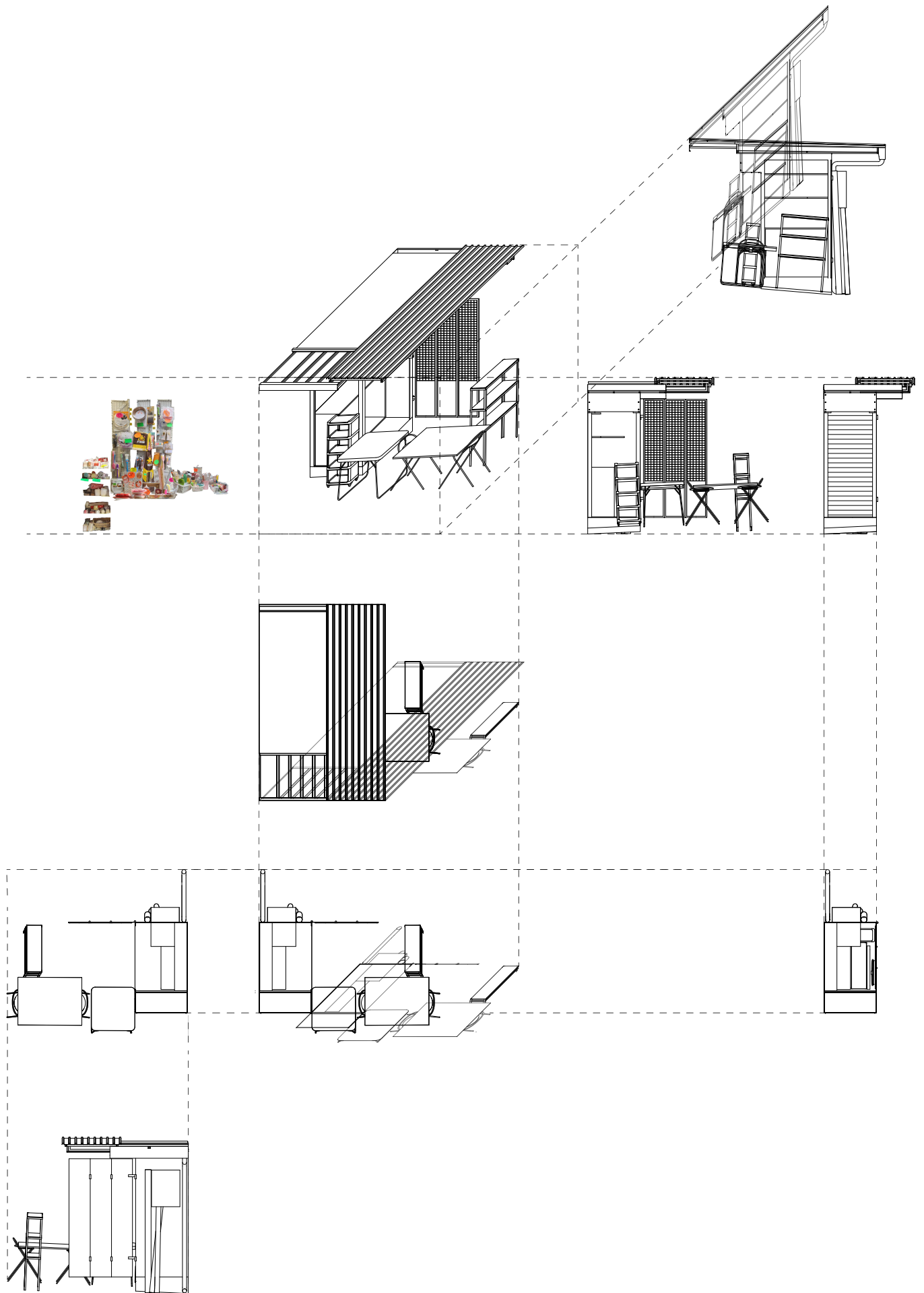

Tang Yuet Yi Daidy

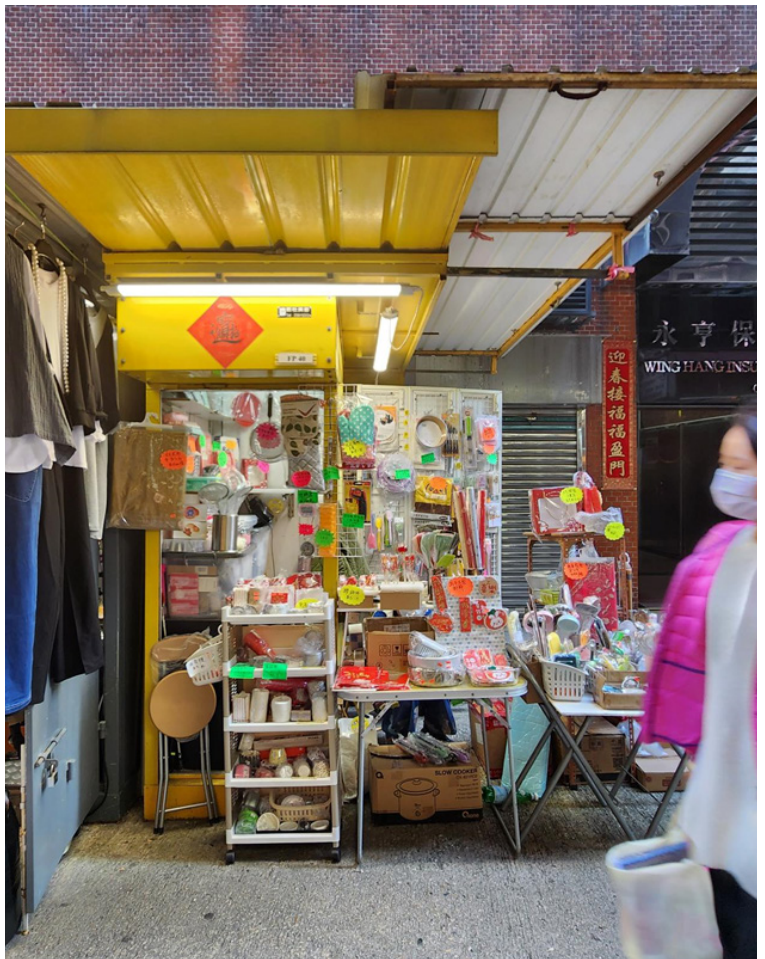
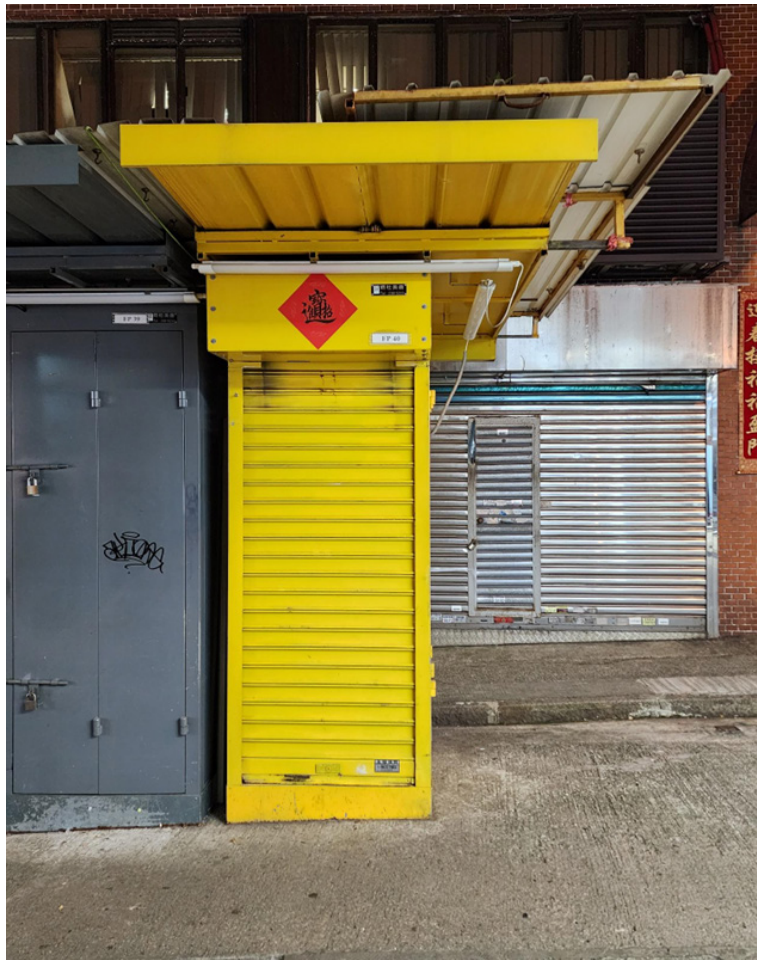

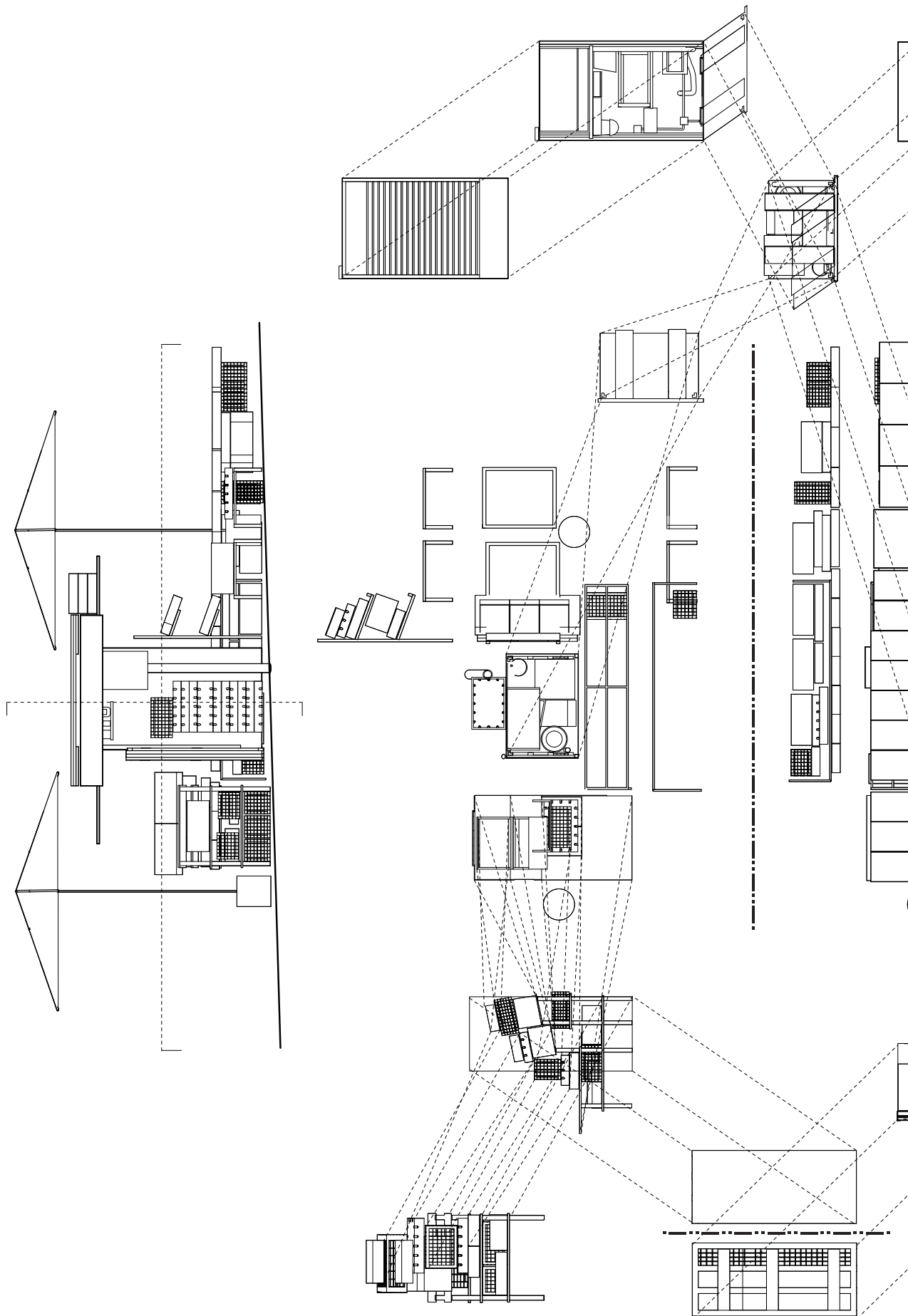

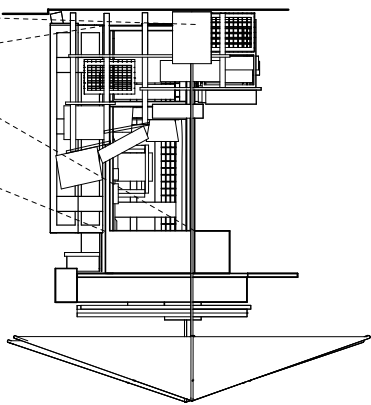
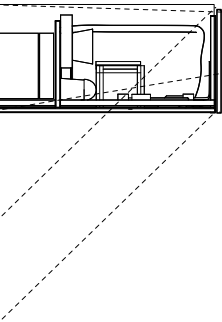
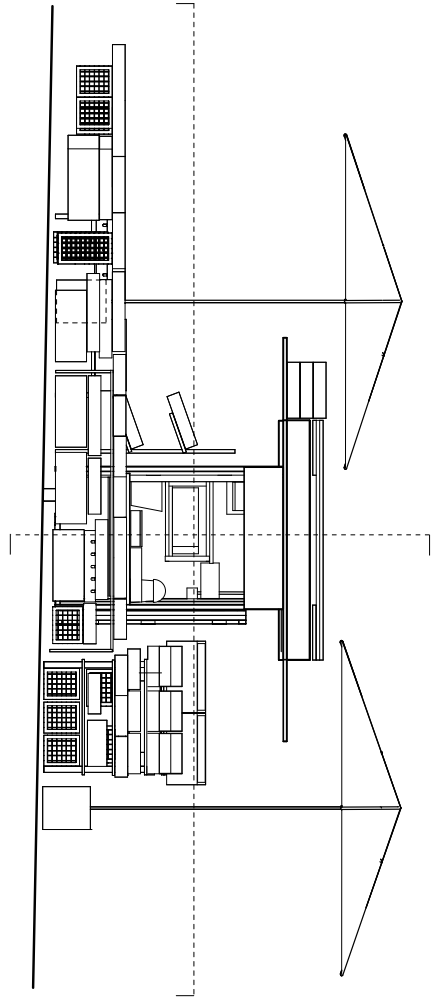
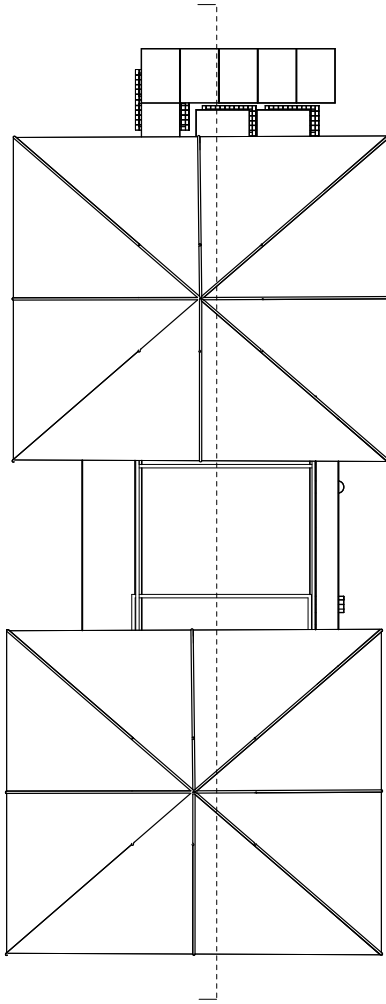
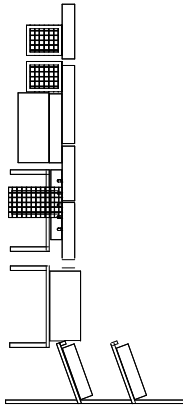
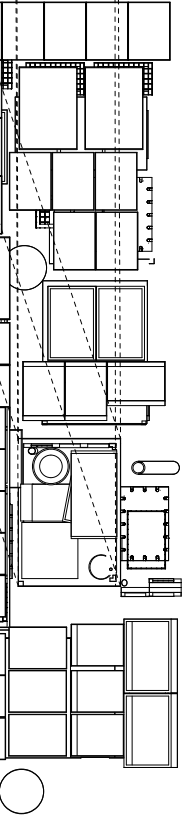
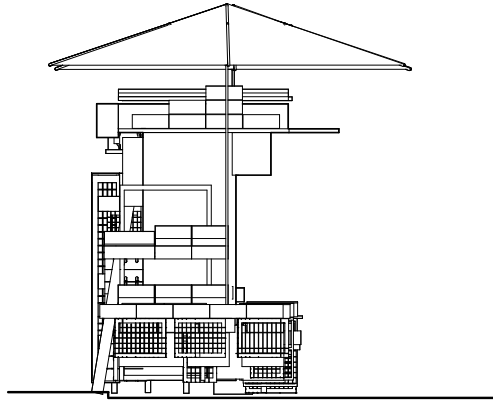
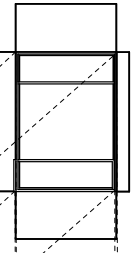

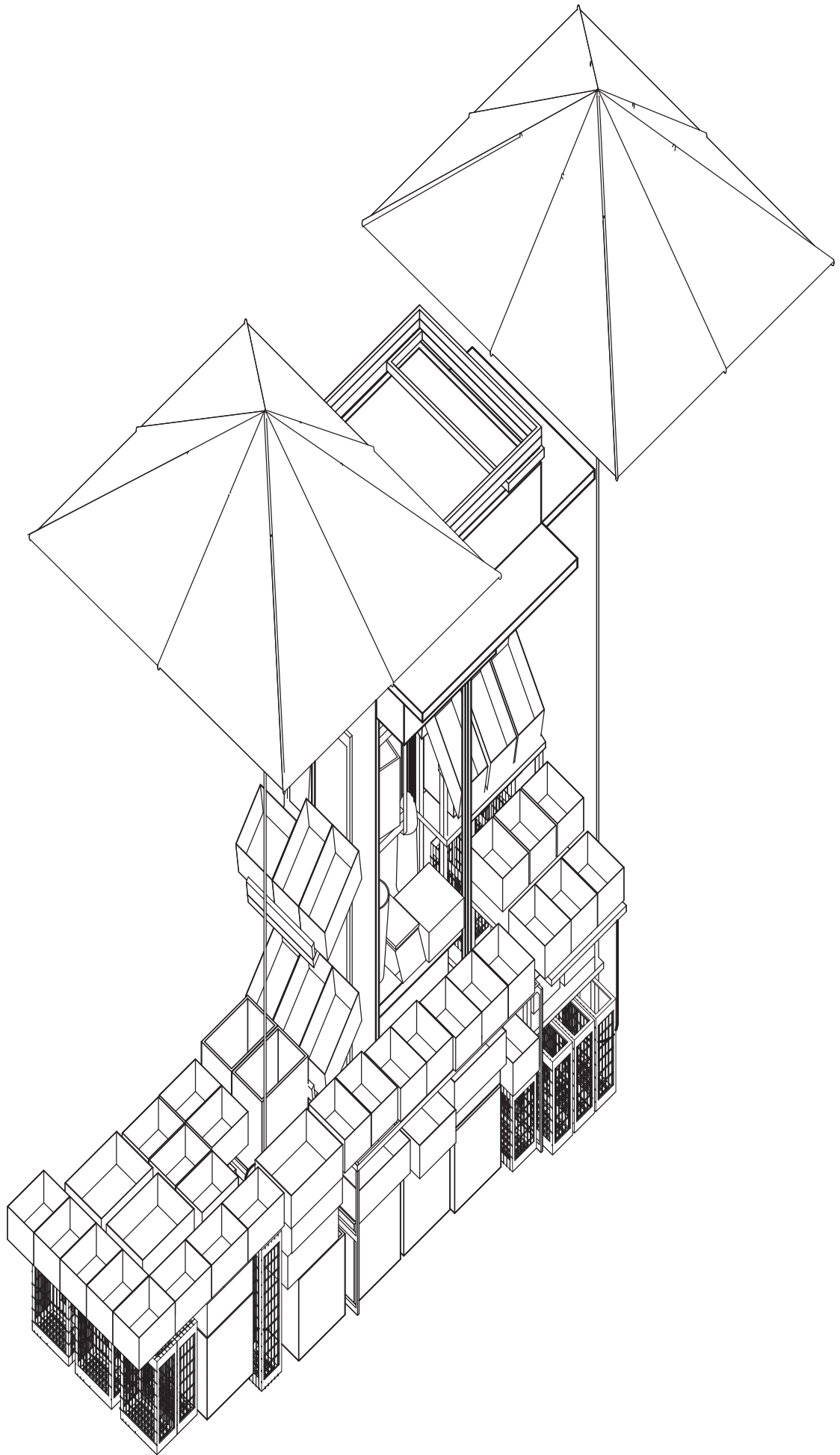

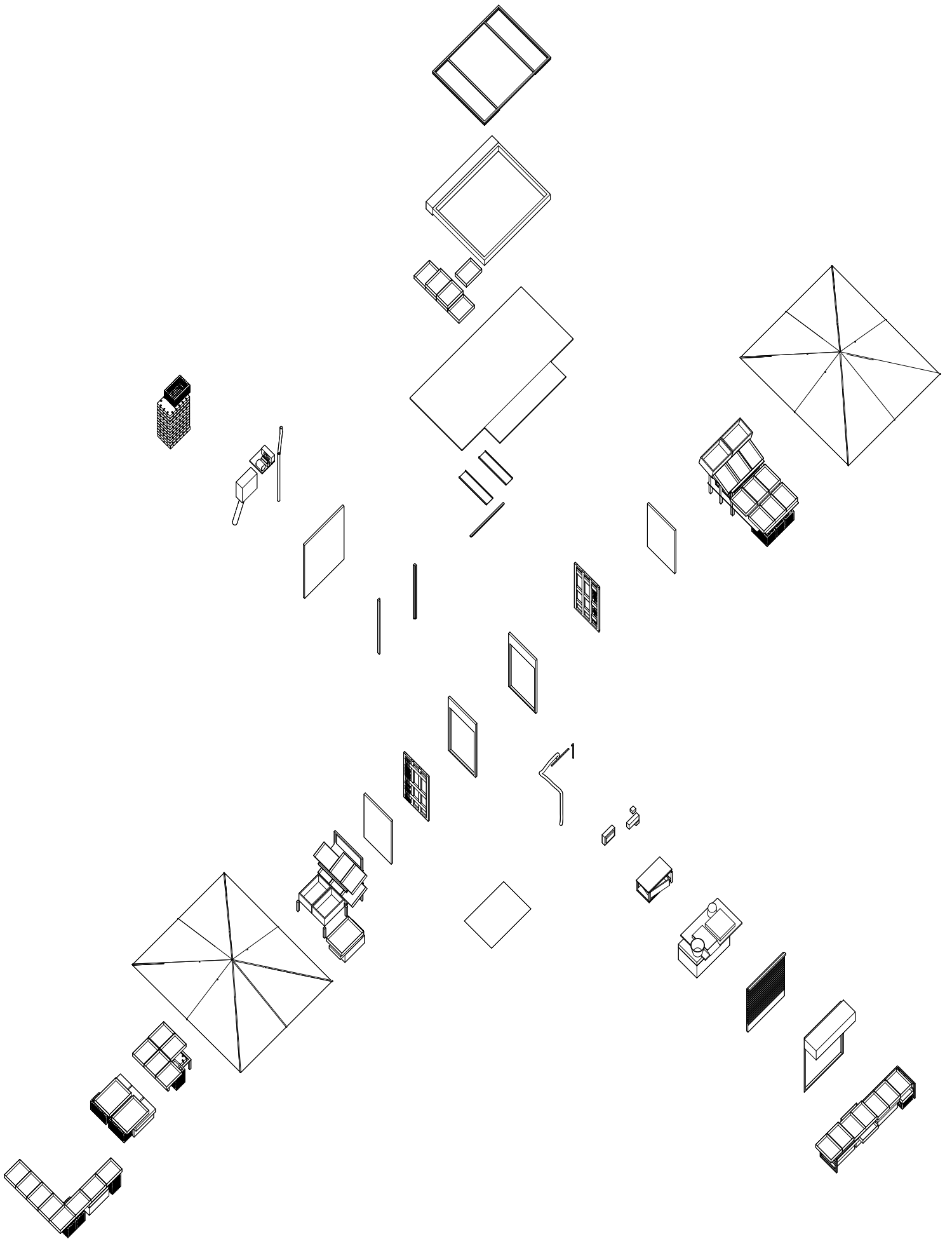

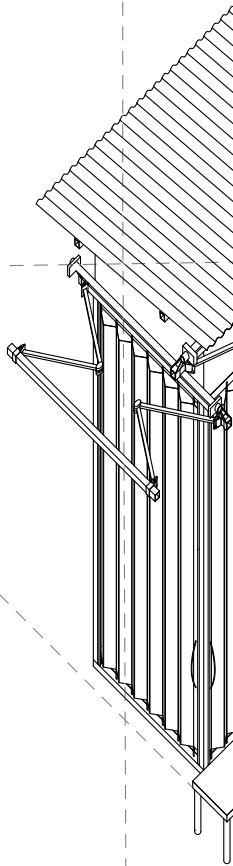
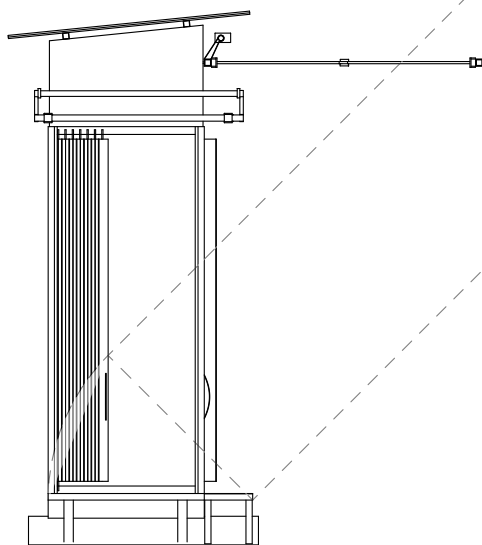
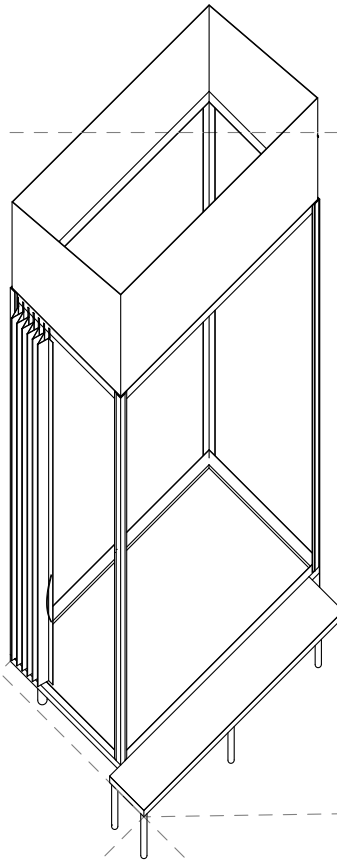
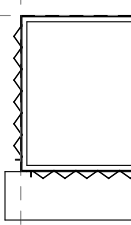
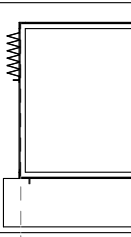
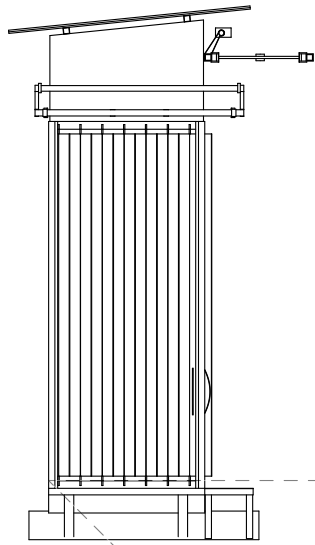

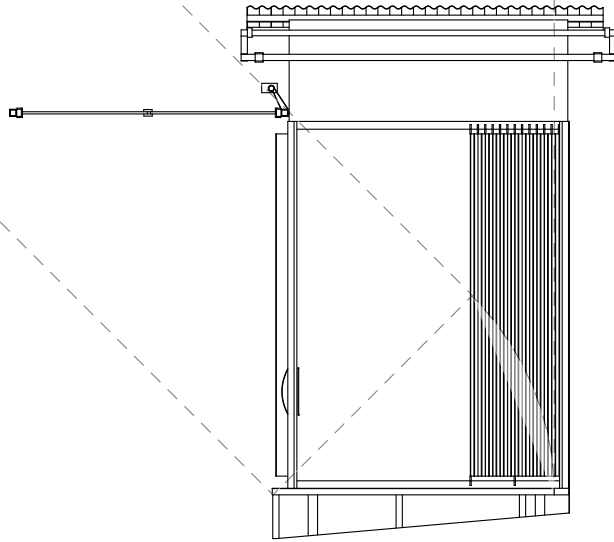
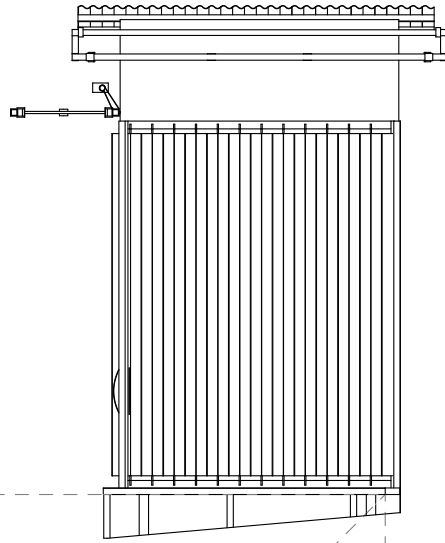
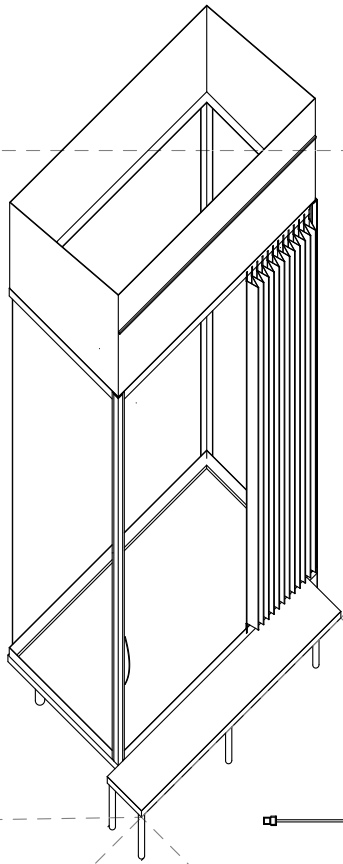
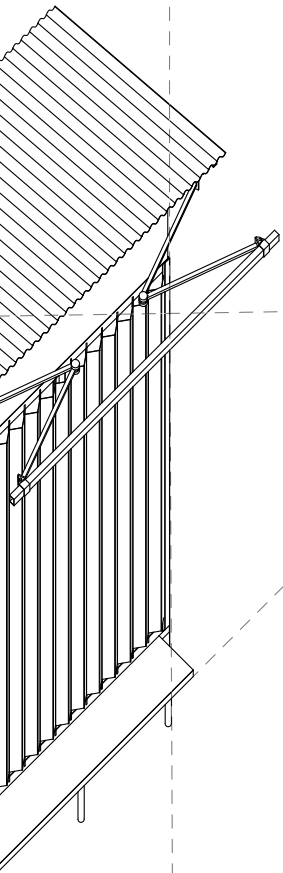
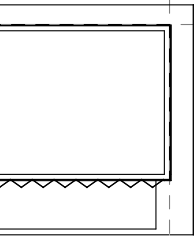
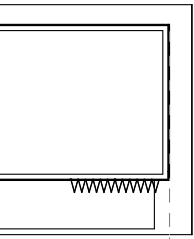

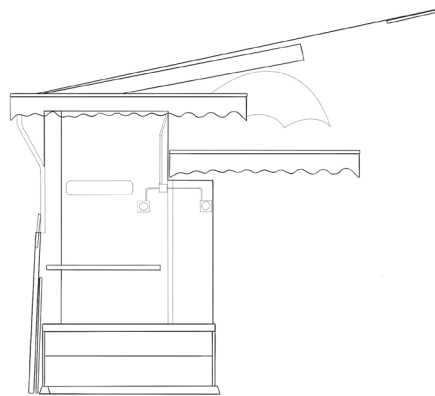
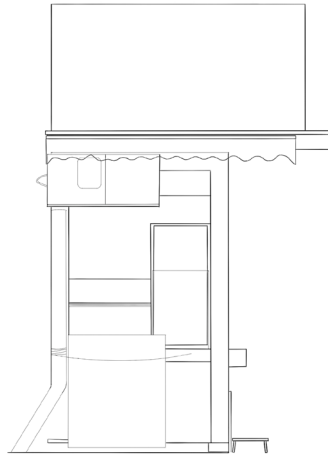
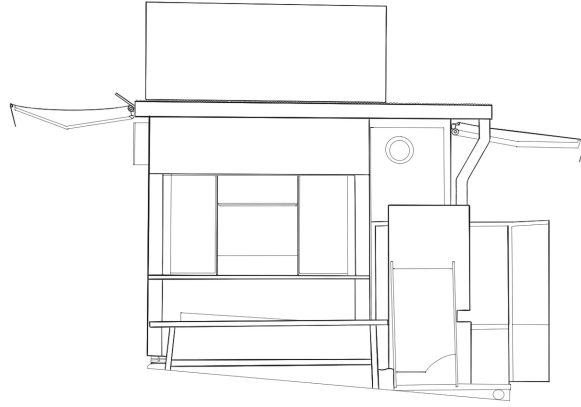



李來記百貨, 17 Peel Street





